



WINSTAR Display Co.,Ltd.
華凌光電股份有限公司



Winstar Display Co., LTD

華凌光電股份有限公司



WEB: <https://www.winstar.com.tw> E-mail: sales@winstar.com.tw

SPECIFICATION

CUSTOMER : _____

MODULE NO.: WF1560BSYAA5ENNO#

<p>APPROVED BY:</p> <p>(FOR CUSTOMER USE ONLY)</p>	<p>PCB VERSION: _____</p> <p>DATA: _____</p>
---	--

SALES BY	APPROVED BY	CHECKED BY	PREPARED BY
			葉虹蘭
ISSUED DATE: 2023/08/24			

TFT Display Inspection Specification: <https://www.winstar.com.tw/technology/download.html>

Precaution in use of TFT module: <https://www.winstar.com.tw/technology/download/declaration.html>



Winstar Display Co., LTD
華凌光電股份有限公司

MODLE NO :

RECORDS OF REVISION

DOC. FIRST ISSUE

VERSION	DATE	REVISED PAGE NO.	SUMMARY
0	2023/08/24		First issue

WINSTAR DISPLAY Co., Ltd.

Contents

1.Module Classification Information

2.Summary

3.General Specifications

4.Absolute Maximum Ratings

5.Electrical Characteristics

6.Pixel Format Image

7.Interface Timings

8.Power ON/OFF Sequence

9.Optical Characteristics

10.Interface

11.Block Diagram

12.Reliability

13.Contour Drawing

14.Other

1.Module Classification Information

W F 1560 B S Y A A5 E N N 0 #
 ① ② ③ ④ ⑤ ⑥ ⑦ ⑧ ⑨ ⑩ ⑪ ⑫ ⑬

①	Brand : WINSTAR DISPLAY CORPORATION												
②	Display Type : F→TFT Type, J→Custom TFT												
③	Display Size : 15.6" TFT												
④	Model serials no.												
⑤	Backlight Type :	F→CCFL, White S→LED, High Light White					T→LED, White Z→Nichia LED, White						
⑥	LCD Polarize Type/ Temperature range/ Gray Scale Inversion Direction	A→Transmissive, N.T, IPS TFT C→Transmissive, N. T, 6:00 ; F→Transmissive, N.T,12:00 ; I→Transmissive, W. T, 6:00 K→Transflective, W.T,12:00 L→Transmissive, W.T,12:00 N→Transmissive, Super W.T, 6:00					Q→Transmissive, Super W.T, 12:00 R→Transmissive, Super W.T, O-TFT V→Transmissive, Super W.T, VA TFT W→Transmissive, Super W.T, IPS TFT X→Transmissive, W.T, VA TFT Y→Transmissive, W.T, IPS TFT Z→Transmissive, W.T, O-TFT						
⑦	A : TFT LCD B : TFT+SCREW HOLES+CONTROL BOARD C : TFT+ SCREW HOLES +A/D BOARD D : TFT+ SCREW HOLES +A/D BOARD+CONTROL BOARD E : TFT+ SCREW HOLES +POWER BOARD					F : TFT+CONTROL BOARD G : TFT+ SCREW HOLES H : TFT+D/V BOARD I : TFT+ SCREW HOLES +D/V BOARD J : TFT+POWER BD							
⑧	Resolution:												
	M	1024768	N	128128	P	1280800	Q	480800	R	640320	S	480128	
	T	800320	U	8001280	V	176220	W	1280398	X	1024250	Y	1920720	
	A5	19201080	A6	480480	A7	10801920	A8	135240	A9	480640	B2	122250	
	B3	340800	B4	2801424	B5	12001920	B6	4801280	B7	800800	B8	40160	
⑨	D: Digital		L:LVDS		M:MIPI		E:eDP						
⑩	Interface:												
	N	Without control board			A	8Bit	B	16Bit		E	eDP	H	HDMI
	I	I2C Interface			R	RS232	S	SPI Interface		U	USB		
⑪	TS:												
	N	Without TS			T	Resistive touch panel		C	Capacitive touch panel (G-F-F)				
	G	Capacitive touch panel (G-G)					C1	Capacitive touch panel (G-F-F)+OCA					
	C2	Capacitive touch panel (G-F-F)+OCR					G1	Capacitive touch panel (G-G)+OCA					
	G2	Capacitive touch panel (G-G)+OCR					B	CTP+GG+USB					
⑫	Version:		X:Raspberry pi			V: Raspberry pi 3B+							
⑬	Special Code		#:Fit in with ROHS directive regulations										

WINSTAR DISPLAY Co., Ltd.

2.Summary

The TFT15.6" is a color active matrix LCD module incorporation Oxide TFT. It is composed of a TFT LCD panel, a backlight, a timing controller, voltage reference, common voltage, column driver, and row driver circuit. This TFT LCD has a 15.6-inch diagonally measured active display area with resolution 1,920 horizontal by 1,080 vertical pixel array.

WINSTAR DISPLAY Co., Ltd.

3. General Specifications

Item	Dimension	Unit
Size	15.6	inch
Dot Matrix	1920 x RGB x 1080	dots
Module dimension	360.0(W) x 212.3(H)x 9.0(D)	mm
Active area	344.16 x 193.59	mm
Pixel pitch	0.17925 (H) x 0.17925 (V)	mm
LCD type	TFT, Normally Black, Transmissive	
Viewing Angle	80/80/80/80	
Backlight Type	LED, Normally White	
TFT Driver IC	TC2055G or equivalent	
TFT Interface	eDP	
With /Without TP	Without TP	
Surface	Anti-Glare	

*Color tone slight changed by temperature and driving voltage.

4. Absolute Maximum Ratings

Item	Symbol	Min	Typ	Max	Unit
Operating Temperature	TOP	-20	—	+70	°C
Storage Temperature	TST	-30	—	+80	°C

Note: Device is subject to be damaged permanently if stresses beyond those absolute maximum ratings listed above

1. Temp. $\leq 50^{\circ}\text{C}$, 80% RH MAX. Temp. $> 50^{\circ}\text{C}$, Absolute humidity shall be less than 80% RH at 50°C

WINSTAR DISPLAY Co., Ltd.

5. Electrical Characteristics

5.1. TFT LCD Module

Parameter	Symbol	Min.	Typ.	Max.	Units	Condition
Logic/LCD Drive Voltage	LCD_VDD	3.0	3.3	3.6	V	
LCD_VDD Current	IDD	-	200	300	mA	Note A,
LCD_VDD Current	IDDMAX	-	-	400	mA	Note B, C
LCD_VDD Power	PDD	-	0.66	1.32	W	Note A, B, C
Inrush Current	IRush	-	-	2	A	Note D, E
Allowable Logic/LCD Drive Ripple Voltage	LCD_VDDrp	-	-	100	mV	Vp-p

Note A : IDDBlack measurement condition, Normal pattern.

Note B : IDDMAX measurement condition, V-Stripe pattern.

Note C : Description of the V-Stripe pattern.

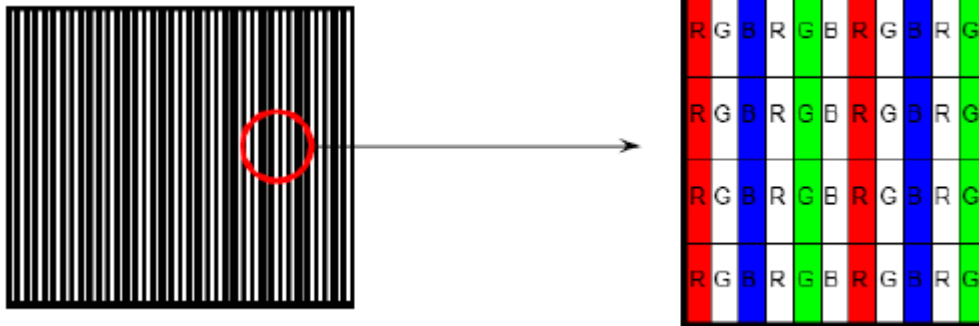

Note D : Measure Condition Figure 1.

Figure 1 LCD_VDD Rising Time

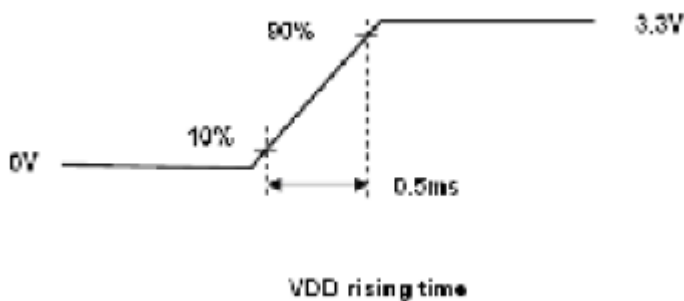

Note E : When the IRush Measure Condition at LCD_VDD rising time=1.5ms, the value of IRush(Typ.)= 1A.

5.2. Backlight Characteristics

Parameter	Symbol	Min.	Typ.	Max.	Units	Condition
LED input	VLED	29.7	33	37.4	V	Ta=25 ° C
LED Forward Current	ILED	-	360	-	mA	
LED Life Time	-	-	30000	-	Hours	Ta=25 ° C

Note A: Calculator value for LED chip specification.

Note B: The LED life time define as the estimated time to 50% degradation of initial luminous.

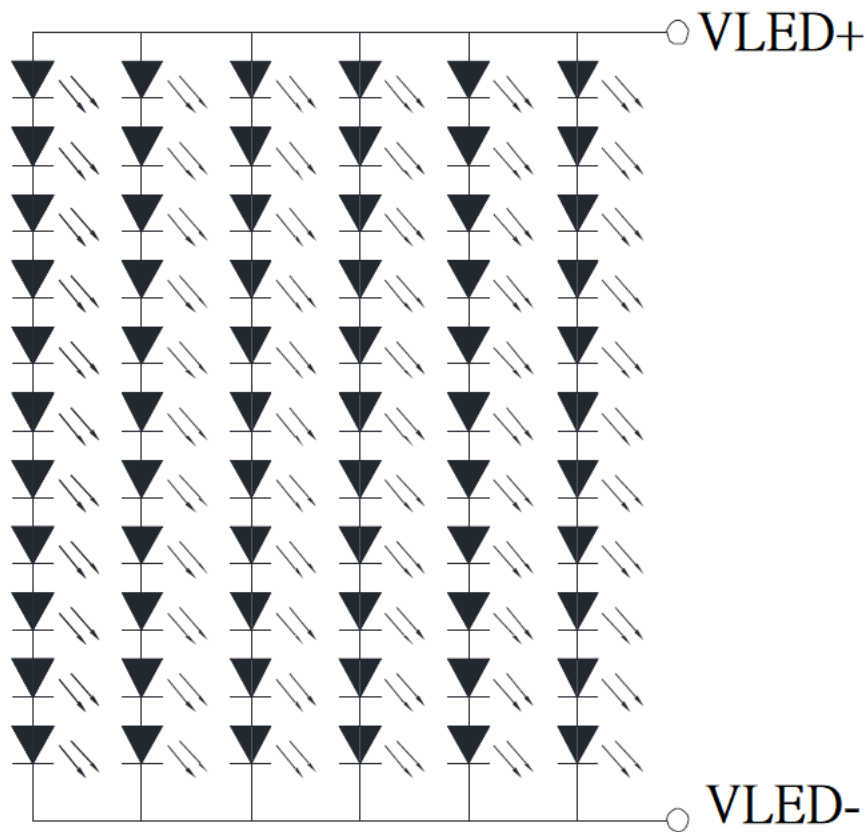

5.3. Signal Electrical Characteristics

Input signals shall be low or High-impedance state when LCD_VDD is off.

It is recommended to refer the specifications of VESA Display Port Standard V1.2 in detail.

Table 1 Display Port Main Link

Parameter	Description	Min.	Typ.	Max.	Unit
V_{CM}	Differentia Common Mode Voltage	0	-	2.0	V
$V_{DIFF P-P}$ Level 1	Differential Peak to Peak Voltage Level 1	0.34	0.40	0.46	V
$V_{DIFF P-P}$ Level 2	Differential Peak to Peak Voltage Level 2	0.51	0.60	0.68	V
$V_{DIFF P-P}$ Level 3	Differential Peak to Peak Voltage Level 3	0.69	0.80	0.92	V
$V_{DIFF P-P}$ Level 4	Differential Peak to Peak Voltage Level 4	1.02	1.20	1.38	V

Note: Follow as VESA display port standard V1.2 at both 1.62 and 2.7Gbps link rates.

Figure 2 Display Port Main Link Signal

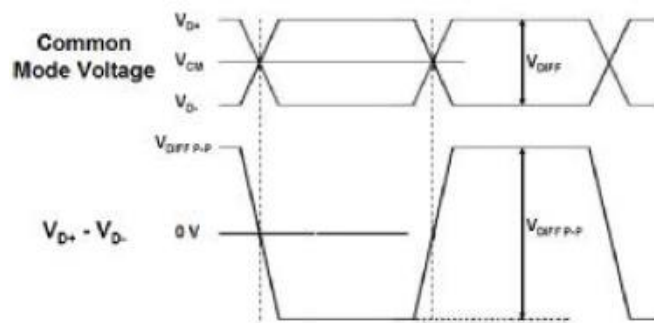

Figure 3 Display Port AUX_CH Signal

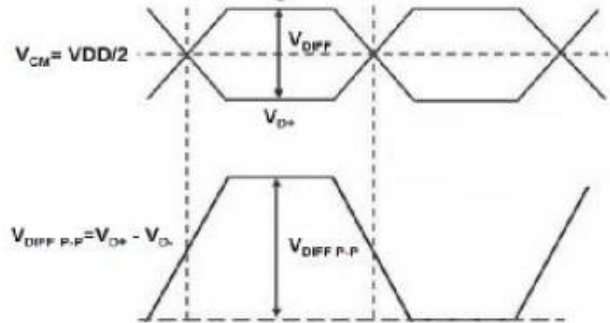

Table 2 Display Port AUX_CH

Parameter	Description	Min.	Typ.	Max.	Unit
V_{CM}	Differentia Common Mode Voltage	0	VDD/2	2	V
$V_{DIFF P-P}$	Differential Peak to Peak Voltage	0.39	-	1.38	V

Note: Follow as VESA display port standard V1.2.

Table 3 Display Port VHPD

Parameter	Description	Min.	Typ.	Max.	Unit
V _{HPD}	HPD Voltage	2.25		3.60	V

Note: Follow as VESA display port standard V1.2

Figure 4 Display Port Interface Power Up/Down Sequence, Normal System Operation

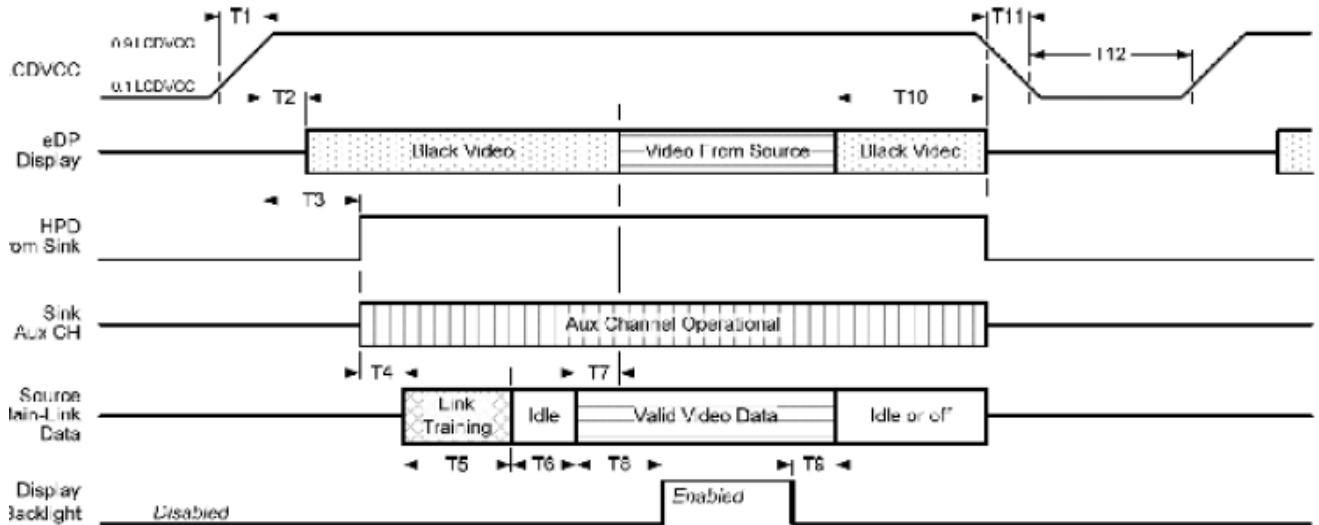

Figure 5 Display Port Interface Power Up/Down Sequence, Aux Channel Transaction Only

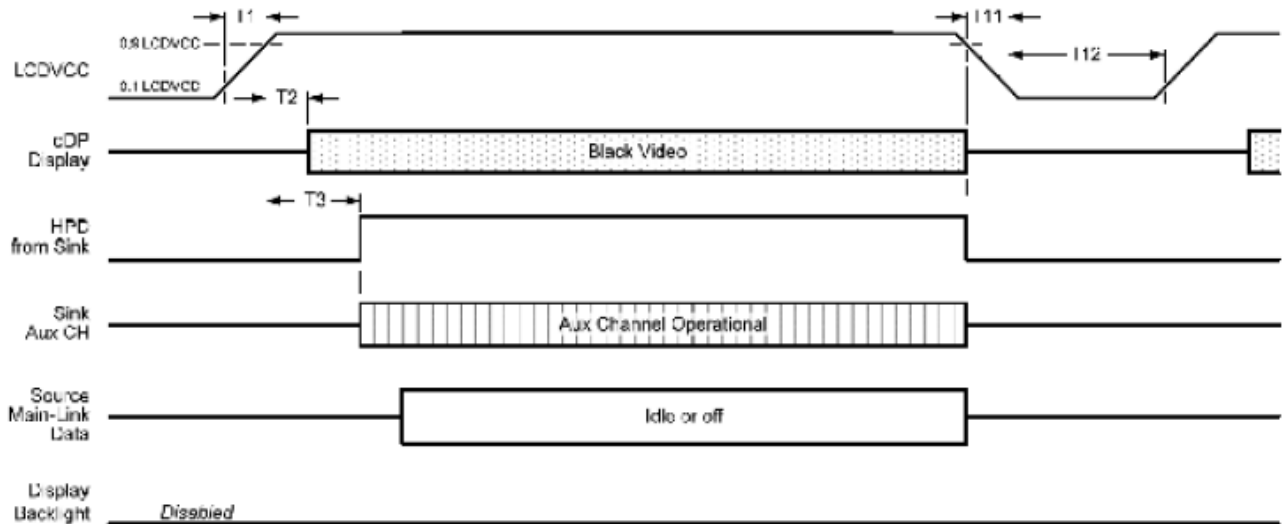

Table 4 eDP Panel Power Sequence Timing Parameters

Timing Parameter	Description	Reqd. By	Limits		Notes
			Min.	Max.	
T1	Power rail rise time, 10% to 90%	Source	0.5ms	10ms	-
T2	Delay from LCD VCC to black video generation	Sink	0ms	200ms	Prevents display noise until valid video data is received from the Source.(see note 1 below)
T3	Delay from LCD VCC to HPD high	Sink	0ms	200ms	Sink Aux Channel must be operational upon HPD high.
T4	Delay from HPD high to link training initialization	Source	-	-	Allows for Source to read Link capability and initialize.
T5	Link training duration	Source	-	-	Dependant on Source link training protocol.
T6	Link idle	Source	-	-	Min accounts for required BS-Idle pattern. Max allows for Source frame synchronization.
T7	Delay from valid video data from Source to video on display	Sink	0ms	50ms	Max allows Sink validate video data and timing.
T8	Delay from valid video from Source to backlight enable	Source	-	-	Source must assure display video is stable.
T9	Delay from backlight disable to end of valid video data	Source	-	-	Source must assure backlight is no longer illuminated.(see note 1 below)
T10	Delay from end of valid video data from Source to power off	Source	0ms	500ms	-
T11	Power rail fall time, 90% to 10%	Source	-	10ms	-
T12	Power off time	Source	500ms	-	-

Note 1: The Sink must include the ability to generate black video autonomously. The Sink must automatically enable black video under the following conditions:

- Upon LCDVCC power-on (within T2 max)
- When the “NoVideoStream_Flag” (VB-ID Bit 3) is received from the Source (at the end of T9)
- When no Main Link data, or invalid video data, is received from the Source. Black video must be displayed within 50ms (max) from the start of either condition. Video data can be deemed invalid based on MSA and timing information, for example.

Note 2: The Sink may implement the ability to disable the black video function, as described in Notes 1, above, for system development and debugging purposes.

Note 3: The Sink must support Aux Channel polling by the Source immediately following LCDVCC power-on without causing damage to the Sink device (the Source can re-try if the Sink is not ready).

The Sink must be able to respond to an Aux Channel transaction with the time specified within T3max.

WINSTAR DISPLAY CO., LTD.

7. Interface Timings

Timing Characteristics

Basically, interface timings should match the 1920 x 1080 /60Hz manufacturing guide line timing.

Table 5 Interface Timings

Parameter	Symbol	Unit	Min.	Typ.	Max.
Signal Clock Frequency	f_{dck}	MHz	140	152.5	165
H Total Time	T_{hp}	clocks	-	2192	-
H Active Time	HA	clocks	1920		
H Blanking	T_{hfp}	clocks	-	272	-
V Total Time	T_{vp}	lines	-	1160	-
V Active Time	VA	lines	1080		
V Blanking	T_{vfp}	lines	-	80	-
V Frequency	f_v	Hz	55	60	65

WINSTAR DISPLAY

8. Power ON/OFF Sequence

LCD_VDD power on/off sequence is as follows. Interface signals are also shown in the chart. Signals from any system shall be Hi-Z state or low level when LCD_VDD is off.

Figure 7 Power Sequence

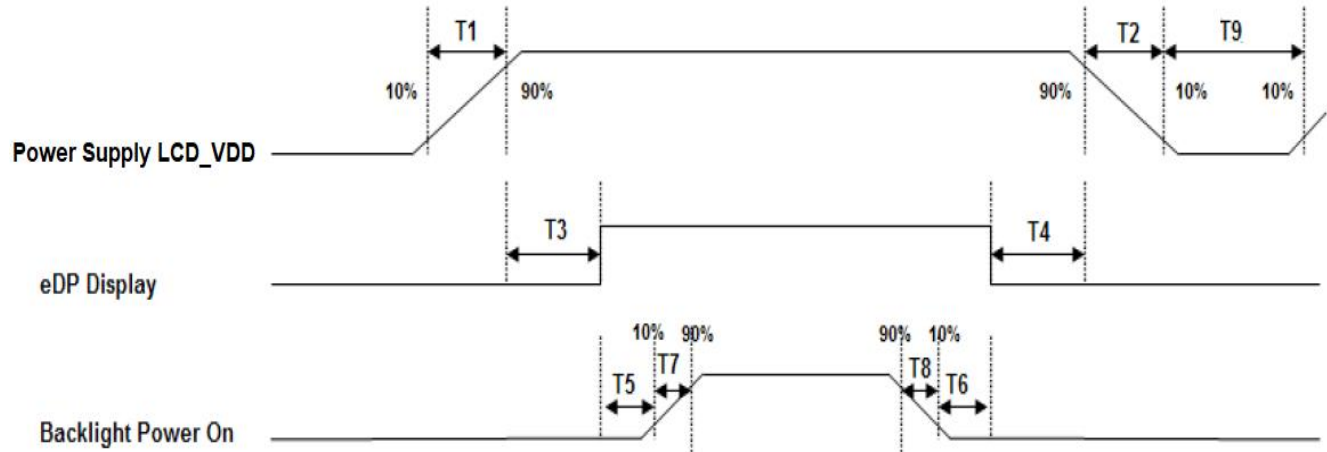

Table 6 Power Sequencing Requirements

Parameter	Unit	Min.	Max.
T1	ms	0.5	10
T2	ms	0	10
T3	ms	0	200
T4	ms	0	50
T5	ms	300	-
T6	ms	200	-
T7	ms	0.5	10
T8	ms	0	10
T9	ms	500	-

9. Optical Characteristics

Item	Symbol	Condition.	Min	Typ.	Max.	Unit	Remark	
Response time	Tr+ Tf	$\theta=0^\circ$ 、 $\phi=0^\circ$	-	25	-	.ms	Note 3	
Contrast ratio	CR	At optimized viewing angle	-	1500	-	-	Note 4,	
Color Chromaticity	White	Wx	$\theta=0^\circ$ 、 $\phi=0$	0.26	0.306	0.36	Note 2,6,7	
		Wy		0.27				0.328
Viewing angle	Hor.	Θ_R	$CR \geq 10$	-	80	-	Deg.	Note 1
		Θ_L		-	80	-		
	Ver.	Φ_T		-	80	-		
		Φ_B		-	80	-		
Brightness	-	-	850	1000	-	cd/m ²	Center of display	
Uniformity	(U)	-	75	-	-	%	Note 5	

Ta=25±2°C

Note 1: Definition of viewing angle range

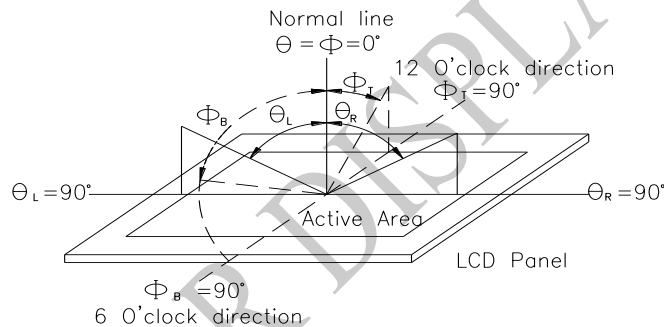

Fig 9.1. Definition of viewing angle

Note 2: Test equipment setup:

After stabilizing and leaving the panel alone at a driven temperature for 10 minutes, the measurement should be executed. Measurement should be executed in a stable, windless, and dark room. Optical specifications are measured by Topcon BM-7orBM-5 luminance meter 1.0° field of view at a distance of 50cm and normal direction.

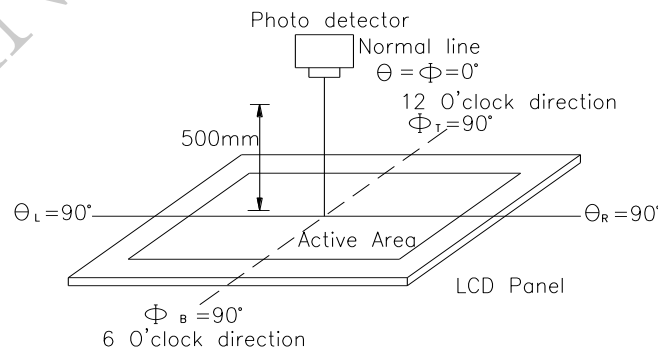
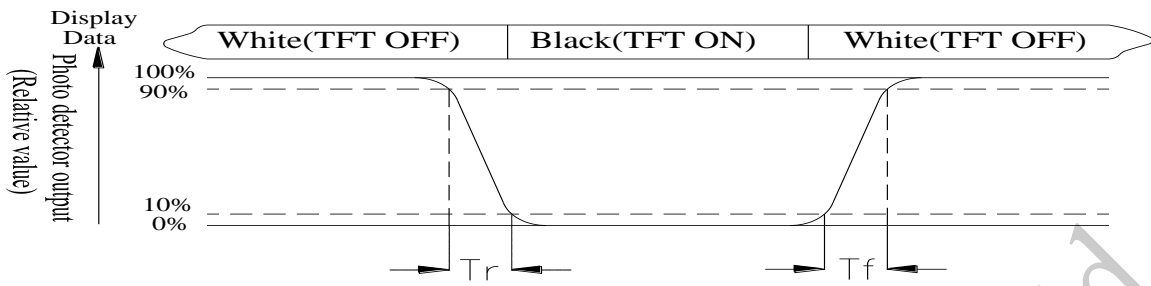

Fig 9.2. Optical measurement system setup

Note 3: Definition of Response time:

The response time is defined as the LCD optical switching time interval between “White” state

and "Black" state. Rise time, T_r , is the time between photo detector output intensity changed from 90% to 10%. And fall time, T_f , is the time between photo detector output intensity changed from 10% to 90%



Note 4: Definition of contrast ratio:

The contrast ratio is defined as the following expression.

$$\text{Contrast ratio (CR)} = \frac{\text{Luminance measured when LCD on the "White" state}}{\text{Luminance measured when LCD on the "Black" state}}$$

Note 5: Definition of Luminance Uniformity

Active area is divided into 9 measuring areas (reference the picture in below). Every measuring point is placed at the center of each measuring area.

Luminance Uniformity (U) = $L_{\min}/L_{\max} \times 100\%$

L = Active area length

W = Active area width

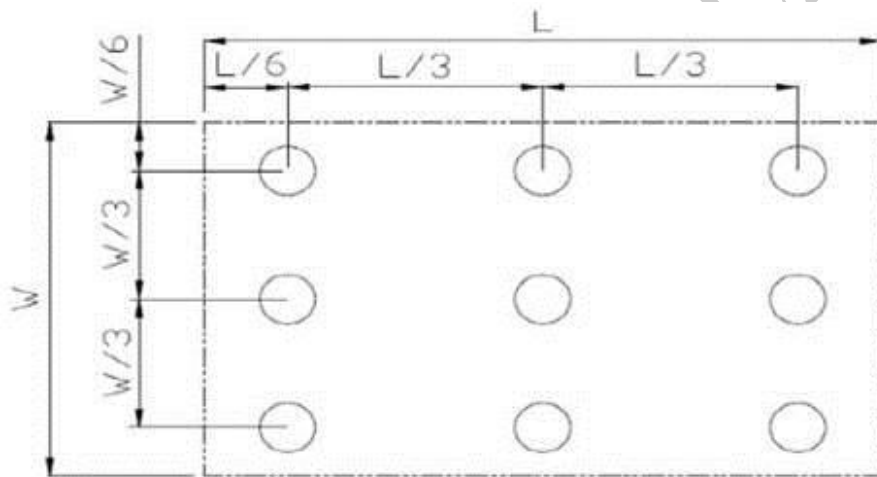

Fig 9.3. Definition of uniformity

Note 6: Definition of color chromaticity (CIE 1931)

Color coordinates measured at the center point of LCD

Note 7: Measured at the center area of the panel when all the input terminals of LCD panel are electrically opened.

10. Interface

10.1. LCM PIN Definition

Pin No.	Signal Name	Description	Remarks
1	NC	Not Connect	
2	H_GND	Ground	
3	Lane1_N	Complement Signal Link Lane 1	
4	Lane1_P	True Signal Line 1	
5	H_GND	Ground	
6	Lane0_N	Complement Signal Link Lane 0	
7	Lane0_P	True Signal Line 0	
8	H_GND	Ground	
9	AUX_CH_P	True Signal Auxiliary Ch.	
10	AUX_CH_N	Complement Signal Auxiliary Ch.	
11	H_GND	Ground	
12-13	LCD_VDD	LCD Logic and Driver Power	+3.3V
14	NC	Not Connect	
15-16	LCD_GND	Ground	
17	HPD	HPD Signal Pin	
18-21	LCD_GND	Ground	
22-30	NC	Not Connect	

Note: All input signals shall be low or Hi-Z state when LCD_VDD is off

10.2. Backlight PIN Definition

Pin No.	Symbol	Description
1	VLED+	Black, LED_ Anode
2	VLED-	White, LED_ Cathode

11. Block Diagram

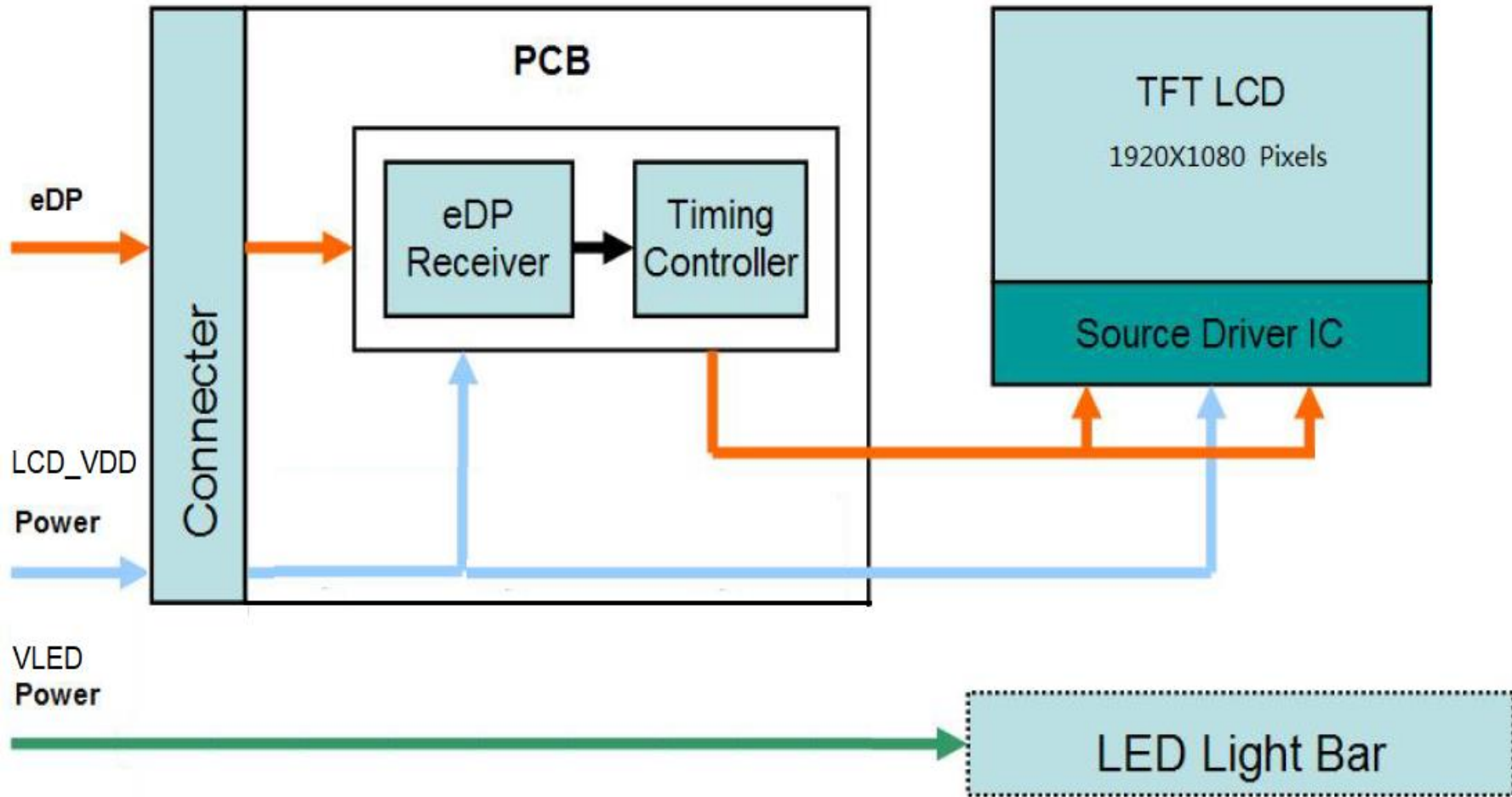

WINN

12. Reliability

Content of Reliability Test (Wide temperature, -20°C~70°C)

Environmental Test			
Test Item	Content of Test	Test Condition	Note
High Temperature storage	Endurance test applying the high storage temperature for a long time.	80°C 200hrs	2
Low Temperature storage	Endurance test applying the low storage temperature for a long time.	-30°C 200hrs	1,2
High Temperature Operation	Endurance test applying the electric stress (Voltage & Current) and the thermal stress to the element for a long time.	70°C 200hrs	—
Low Temperature Operation	Endurance test applying the electric stress under low temperature for a long time.	-20°C 200hrs	1
High Temperature/ Humidity Operation	The module should be allowed to stand at 50°C,80%RH max	50°C,80%RH 96hrs	1,2
Thermal shock resistance	The sample should be allowed stand the following 10 cycles of operation <div style="text-align: center;"> <p style="margin: 0;">-20°C 25°C 70°C</p> <p style="margin: 0;">30min 5min 30min</p> <p style="margin: 0;">1 cycle</p> </div>	-20°C/70°C 10 cycles	—
Vibration test	Endurance test applying the vibration during transportation and using.	Total fixed amplitude : 1.5mm Vibration Frequency : 10~55Hz One cycle 60 seconds to 3 directions of X,Y,Z for Each 15 minutes	3
Static electricity test	Endurance test applying the electric stress to the terminal.	VS=±8KV(contact), ±15KV(air), RS=330Ω CS=150pF 10 times	—

Note1: No dew condensation to be observed.

Note2: The function test shall be conducted after 4 hours storage at the normal Temperature and humidity after remove from the test chamber.

Note3: The packing have to including into the vibration testing.

13. Contour Drawing

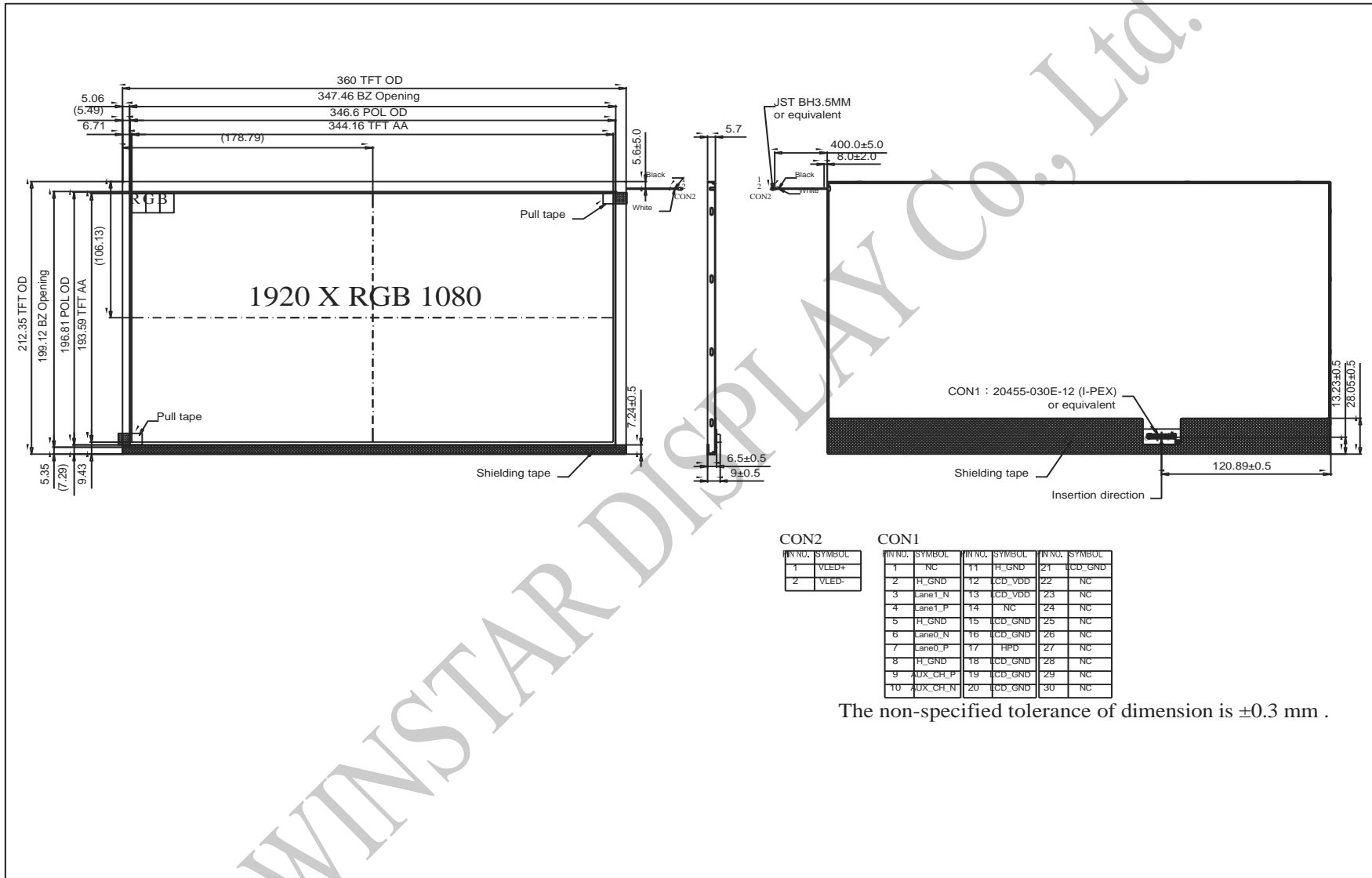

The non-specified tolerance of dimension is ± 0.3 mm .



1、Panel Specification :

- 1. Panel Type : Pass NG , _____
- 2. View Direction : Pass NG , _____
- 3. Numbers of Dots : Pass NG , _____
- 4. View Area : Pass NG , _____
- 5. Active Area : Pass NG , _____
- 6. Operating : Pass NG , _____
- 7. Storage Temperature : Pass NG , _____
- 8. Others : _____

2、Mechanical

- 1. PCB Size : Pass NG , _____
- 2. Frame Size : Pass NG , _____
- 3. Material of Frame : Pass NG , _____
- 4. Connector Position : Pass NG , _____
- 5. Fix Hole Position : Pass NG , _____
- 6. Backlight Position : Pass NG , _____
- 7. Thickness of PCB : Pass NG , _____
- 8. Height of Frame to PCB : Pass NG , _____
- 9. Height of Module : Pass NG , _____
- 10. Others : Pass NG , _____

3、Relative Hole Size :

- 1. Pitch of Connector : Pass NG , _____
- 2. Hole size of Connector : Pass NG , _____
- 3. Mounting Hole size : Pass NG , _____
- 4. Mounting Hole Type : Pass NG , _____
- 5. Others : Pass NG , _____

4、Backlight Specification :

- 1. B/L Type : Pass NG , _____
- 2. B/L Color : Pass NG , _____
- 3. B/L Driving Voltage (Reference for LED) : Pass NG , _____
- 4. B/L Driving Current : Pass NG , _____
- 5. Brightness of B/L : Pass NG , _____
- 6. B/L Solder Method : Pass NG , _____
- 7. Others : Pass NG , _____



Winstar Module Number : _____

Page: 2

5、Electronic Characteristics of Module :

- 1. Input Voltage : Pass NG , _____
- 2. Supply Current : Pass NG , _____
- 3. Driving Voltage for LCD : Pass NG , _____
- 4. Contrast for LCD : Pass NG , _____
- 5. B/L Driving Method : Pass NG , _____
- 6. Negative Voltage Output : Pass NG , _____
- 7. Interface Function : Pass NG , _____
- 8. LCD Uniformity : Pass NG , _____
- 9. ESD test : Pass NG , _____
- 10. Others : Pass NG , _____

6、Summary :

Sales signature : _____

Customer Signature : _____

Date : / / _____

